

10 YEAR MANUFACTURER'S

LIMITED WARRANTY

All parts of this Kingston Brass faucet are warranted to the original retail purchaser to be free from defects in material and workmanship for a period of Ten(10) years from the date of purchase as shown on the purchaser's receipt.

This warranty is limited to defective parts only, labor charges and/or damage resulting from improper installation, repair or replacements, as well as incidental and consequential damages connected therewith are excluded.

Any damage to this faucet as a result of misuse, abuse, neglect, accident, or improper installation or any use not consistent with the instructions furnished by us, will void this warranty.

Replacement parts can be obtained from your local dealer. Freight cost is not covered by manufacturer.

CAUTION!!!

1. Water lines must be completely flushed before use, to avoid debris & clogs in your water system leading to mal-function and reduction of water flow.
2. Warranty to be void if water lines are not flushed before use of new faucet.
3. Use of abrasives of any strength may damage the finish of your faucet and void this warranty.

KINGSTON BRASS



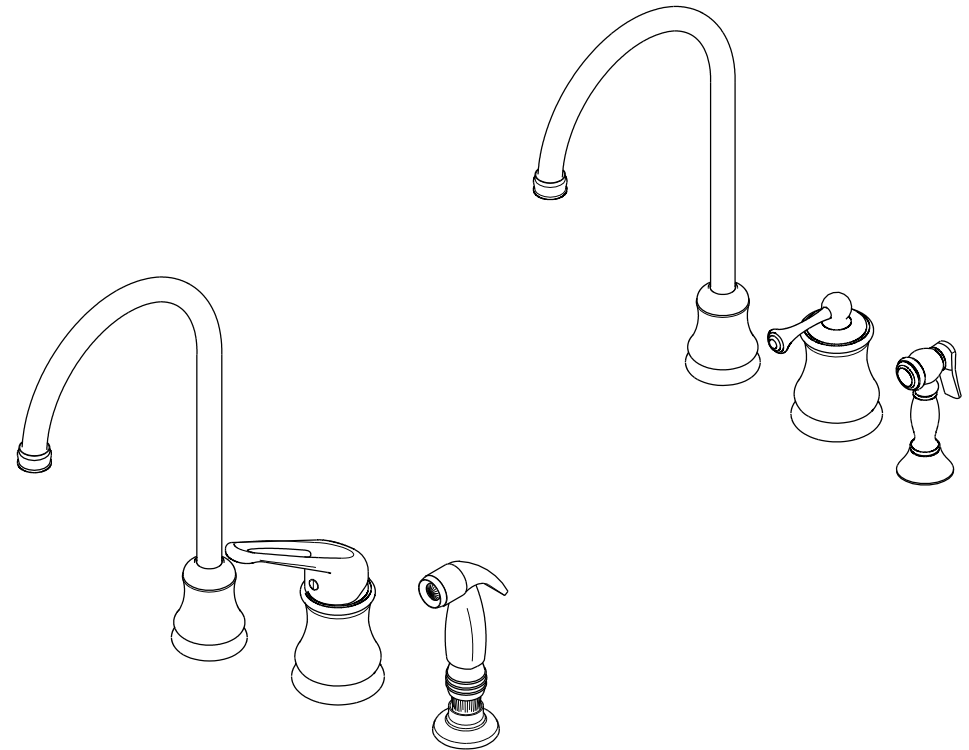

THE TRADITION OF FINE BRASS



PROBLEMS SHOOTING

PROBLEM	CAUSE	CORRECTIVE ACTION
Leaks underneath handle	Bonnet nut has come loose	Remove the handle and tightening the bonnet nut
Leaks from the spout	Valve seat and spring are worn	Replace the valve seat and spring
Inconsistent water flow pattern	Aerator is dirty or aged	Release aerator and check on rubber gasket if aged or replace with new aerator
Faucet is dirty	Caused by stubborn water spot	Clean with mild soap and warm water as often as possible
Handles works backward	Handle install backward	Rotate the right stem stop assembly 180 degrees

Parts:

Lock Nut	Cone Washer & Coupling Nut	Rubber Washer & Metal Washer & Brass Nut	Flexible Water Supply Line
			
X2	X2	X1	X1

www.kingstonbrass.com

TOLL-FREE CUSTOMER SERVICE: 1-877-2-KBRASS
TECHNICAL SUPPORT E-mail: service@kingstonbrass.com
 12775 Reservoir Street, Chino, CA91710

INSTALLATION INSTRUCTIONS

For Use With KB's Widespread Single Handle Kitchen Faucet with Sprayer

Before Beginning Installation.

- 1 Flush plumbing lines to clear debris in pipe and plumbing lines to avoid existing clogs into waterway & cartridge system of new faucet fixture.
- 2.Shut off both supply lines after flushing

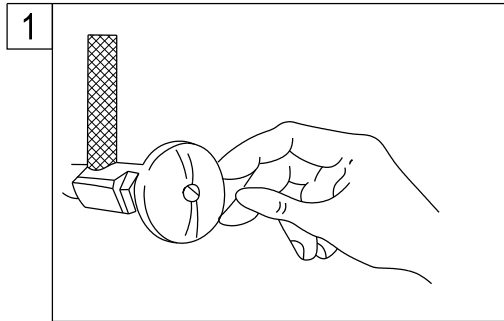
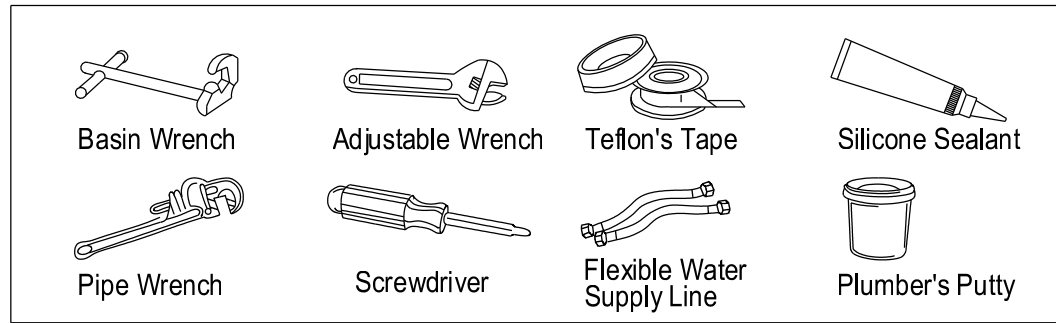

1. Shut off hot and cold water supply under sink. Plug sink drain with cloth to avoid losing small parts. Remove old faucet.

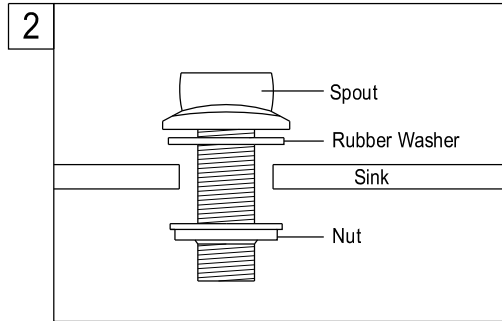

2. Install spout and rubber washer through sink. Be sure to keep rubber washer above the sink surface. Attach nut to spout and hand tightens from underneath sink. Be careful not to over tighten.

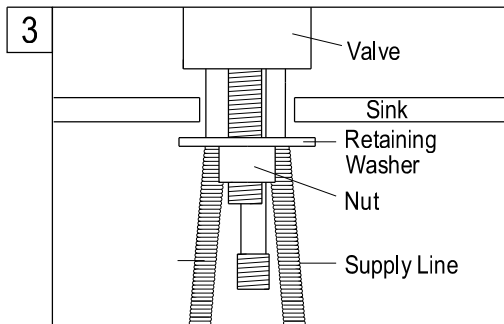

3. Install Valve. Insert valve through sink. Position valve so that the longer supply line is on the left side. Place retainer washer over the threaded stem and thread nut into place. Tighten nut using adjustable wrench. Be sure to keep rubber washer above the sink surface.

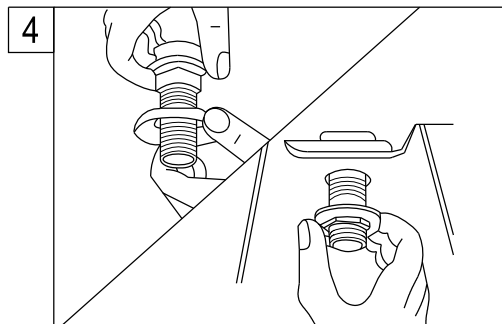

4. Install Sprayer: Insert hose guide through guide flange and snap into place. Install guide through sink and attach with mounting nut.

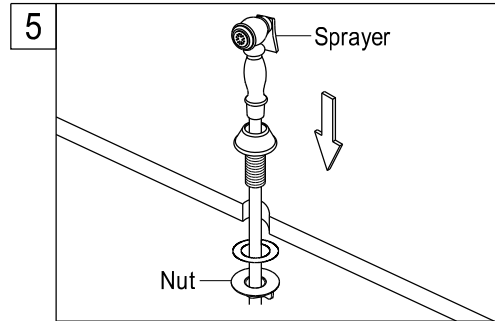

5. Attached sprayer head to hose and hand tightens only. Teflon's tape is not required. Drop Sprayer hose through hose guide and let it rest in place.

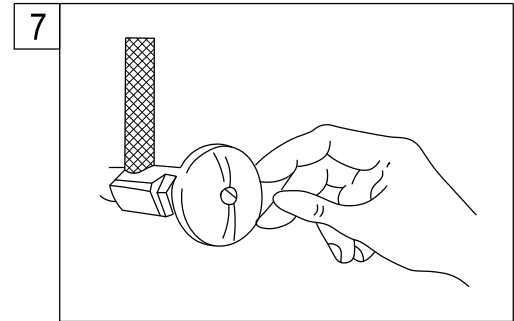

7. Turn on hot and cold water at the valves and check for leaks. If leak is found, slightly tighten connection. Do not over tighten.

NOTE: If additional adapters or supply tubes are required, you can purchase them from the store where you bought the faucet.

NOTE: Adapter parts are not included in the package

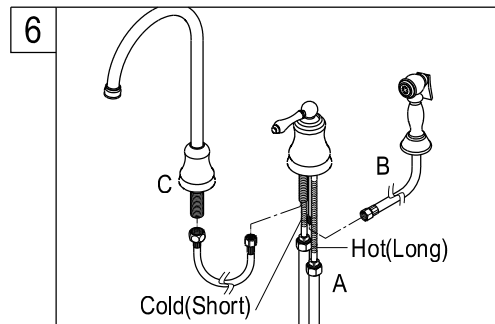

6. Water Line Connections
 A. Connect hot and cold water supply line to faucet.
 B. Connect sprayer hose to the partially threaded inlet stem on the faucet valve.
 C. Connect small end of metal braided hose to the faucet valve. Connect other end of hose to the spout.
 Tighten all connections securely with a wrench. Be careful not to over tighten.

CAUTION: If faucet supply lines need to be bent, grip tubes at point of bending and slowly pull tube into position. Extreme care must be exercised. Kinked tubes will void the warranty.

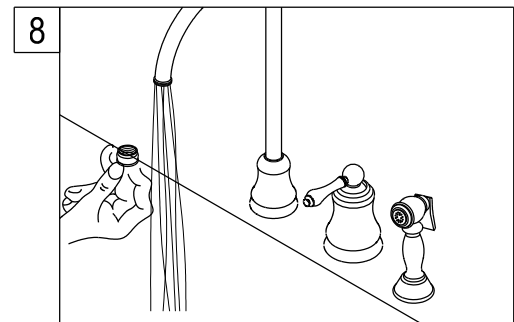

8. Remove the aerator before turning on your new faucet for the first time. This is to prevent any deposits from clogging your aerator. Allow both hot and cold water to run for one minute. Replace aerator.